

Creo® Package Overview

POWERFUL DESIGN SOLUTIONS TAILORED FOR YOUR ROLE IN PRODUCT DEVELOPMENT

PTC delivers the most scalable range of role-based product development packages on the market today. No matter which package you choose, you'll get the industry's fastest, most comprehensive tools: easy to use, competitively priced, and always upgradeable—to meet the varied demands of your specific role and business.

The complete set of design solutions on a single, integrated platform

Product design firms and manufacturing companies are under constant pressure to develop more products in less time, without sacrificing innovation or quality. Many participants throughout an enterprise are often involved in developing products. Marketing professionals, industrial designers, engineers, analysts, managers, service professionals and many other roles need design software tools that are best suited for their tasks and that work well together, in order to maximize efficiency and accelerate product development processes.

Creo provides everyone in the product development process – engineers and the extended enterprise – the right tools needed to achieve the highest quality design in the fastest possible time. The unlimited scalability of Creo also allows you to add new users and expand capabilities with new apps and extensions as your needs grow. And since Creo is an integral

part of PTC's Product Development System, your 3D CAD solution will seamlessly connect to PTC's industry-leading solutions, including; Windchill® for content and process management; Mathcad® for engineering calculations; and Arbortext® for dynamic information delivery.



Creo 3D CAD packages for engineers

Creo provides a scalable set of packages for design engineers that are optimized to meet a variety of specialized needs. Whether you require added design flexibility, advanced assembly design capabilities, faster piping and cabling design features, advanced surfacing or comprehensive virtual prototyping capabilities, you can select the right package to get the precise capabilities you need to achieve your design goals.

2D and 3D Design Solutions	Creo Engineer I	Creo Engineer II	Creo Engineer III	Creo Engineer IV
Creo Apps				
Creo Parametric	•	•	•	•
Creo Extensions				
Creo Flexible Modeling Extension	•	•	•	•
Creo Manikin Extension	•	•	•	•
Creo Advanced Assembly Extension	} Choose 1 of 3 options		•	•
Creo Behavioral Modeling Extension			•	•
Creo Mechanism Dynamics Extension			•	•
Creo Interactive Surface Design Extension			•	•
Creo Piping & Cabling Extension			•	•
Creo Simulation Extension				•
Creo Tolerance Analysis Extension				•
Creo Rights Management Extension				•
Engineering Calculations				
Mathcad				•
Data Management & Collaboration				
Windchill PDMLink®		•	•	•
Windchill ProjectLink™			•	•

Creo Engineer I

This 3D CAD value package is powerful, easy to use, flexible and fully scalable. Creo Engineer I features the industry's broadest range of 3D solid modeling and design capabilities for creating high-quality designs in less time. Capabilities of the package include:

- Creo Parametric
 - Comprehensive 3D Solid Modeling
 - Detailed Documentation: 2D and 3D Drawings
 - Freestyle (Interactive Industrial Design)
 - Technical Surfacing
 - Assembly Modeling
 - Weld Modeling and Documentation
 - Mechanism Design and Design Animation
 - ModelCHECK™ Design Validation Tool
 - Data Interoperability and Import Data Repair
 - Integrated Web Capabilities
 - Complete Library of Parts, Features, Tools and More

Plus two unique design extensions to further enhance your design for your target customer and increase design flexibility.

- Creo Flexible Modeling Extension – provides the ultimate flexibility in editing 3D CAD geometry while fully retaining design intent
- Creo Manikin Extension – provides digital human modeling capabilities so you can optimize your design for human interactions

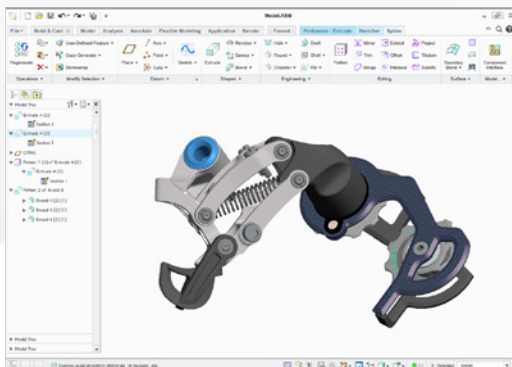

Creo Engineer II

Designed for engineers who need more design power and data management capabilities. This package provides you with more advanced assembly design, performance optimization and the industry-leading solution for managing your valuable CAD data. The package includes:

- All solutions in the Creo Engineer I package
- Choice of one of the following design and analysis extensions:
 - Creo Advanced Assembly Extension
 - Creo Behavioral Modeling Extension
 - Creo Mechanism Dynamics Extension
- Windchill PDMLink for broader engineering content and process management

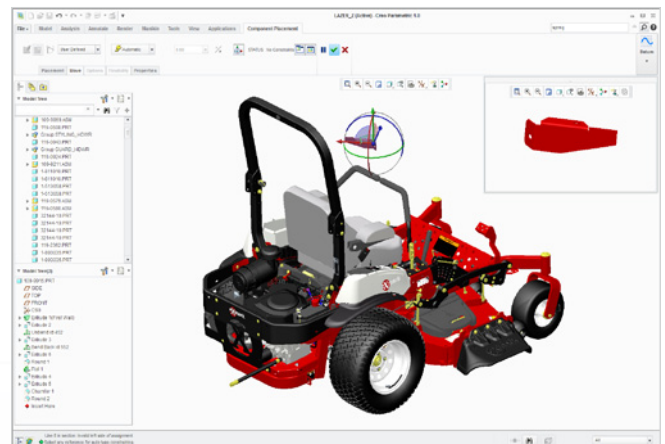

Creo Engineer III

A robust product development solution that's optimized to solve the complex needs of today's globally dispersed development teams. Creo Engineer III enables teams to work concurrently, share information efficiently, promote design reuse, and leverage an automated change process that ensures integrity and traceability of designs. The package includes:

- All solutions in the Creo Engineer II package, including all three extension options:
 - Creo Advanced Assembly Extension
 - Creo Behavioral Modeling Extension
 - Creo Mechanism Dynamics Extension
- Two additional high-performance design extensions:
 - Creo Interactive Surface Design Extension
 - Creo Piping & Cabling Extension
- Windchill ProjectLink – Web-based collaboration and project management capabilities

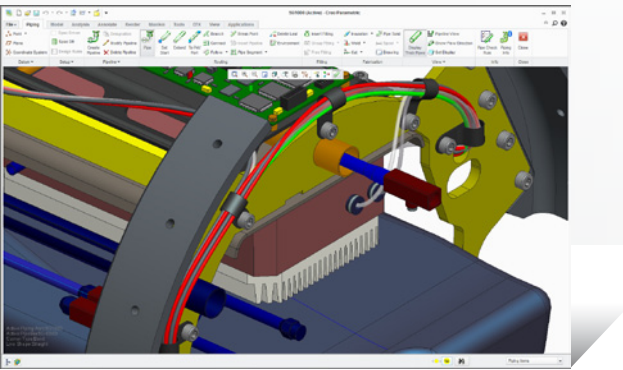

Creo Engineer IV

The industry's most comprehensive product development package, delivers more virtual prototyping capabilities to further increase your product development process productivity. You can capture critical engineering calculations and perform CAE analyses to improve your verification and validation speed and accuracy. This package also enables you to protect your valuable design IP to improve your design outsourcing processes.

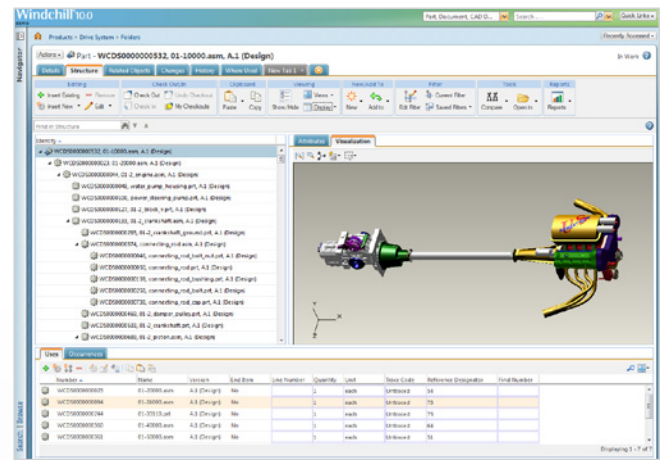

The package includes:

- All solutions in the Creo Engineer III package
- Mathcad – solves and documents engineering calculations
- Creo Simulate – performs key simulation and analysis tasks
- Creo Tolerance Analysis Extension powered by CETOL™ Technology – adds powerful tolerance analysis capabilities such as 1-D stack-up, contribution and sensitivity analyses within the design environment
- Creo Rights Management Extension – protects your design IP dynamically and persistently. Leverages Adobe® LiveCycle® Rights Management server to create, manage and monitor access policies

3D Design Packages	Creo Analyst	Creo Industrial Designer	Creo Concept Engineer*	Creo Design Reviewer
Creo Apps				
Creo Direct	•		•	•
Creo Parametric		•		
Creo Layout			•	
Creo Simulate	•			
Creo Sketch		•		•
Creo View MCAD				•
Creo Extensions				
Creo Flexible Modeling Extension		•		
Creo Advanced Simulation Extension	•			
Creo Interactive Surface Design Extension		•		
Creo Advanced Rendering Extension		•		

*This package is planned to be available late fall 2011.

Creo 3D design packages for more roles in the enterprise

Creo provides packages to meet the varied demands of roles outside the design engineering teams who need to participate in product development. These packages combine Creo apps and extensions to deliver the optimal set of capabilities for roles such as analysts, industrial designers and others. Now everyone – CAD experts and casual users alike – can access 2D and 3D design data with easy to use tools that enable them to contribute to product development more effectively and efficiently.

Creo Analyst

This powerful virtual prototyping package provides you a complete range of structural and thermal analysis capabilities, including advanced, nonlinear CAE features. In addition, you can streamline your CAE workflow using direct modeling capabilities that help you prepare models for analysis faster than ever before. You can quickly edit models to de-feature or simplify the geometry with less frustration without waiting for the design engineer to do the task.

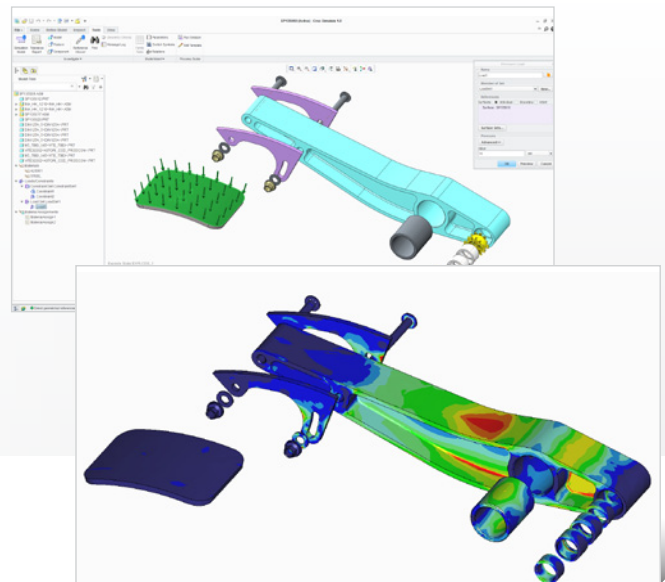

The broad range of CAE capabilities and streamlined workflow will enable you to improve your verification and validation process.

Capabilities of the package include:

- Creo Simulate for structural and thermal simulation
- Creo Advanced Simulation Extension for nonlinear and other advanced CAE analyses
- Creo Direct for fast, easy 3D direct modeling capabilities

Creo Industrial Designer

This comprehensive CAID package gives you all the design flexibility and power needed to create beautiful products and stunning photorealistic images. Now you have the utmost in design freedom and flexibility to quickly create complex shapes and high-quality surfaces. With Freestyle design capabilities and other powerful surfacing Style features you can maximize the aesthetics and present them in the best light. The productivity gains delivered by the Creo Industrial Designer package will accelerate concept design and detailed design processes.

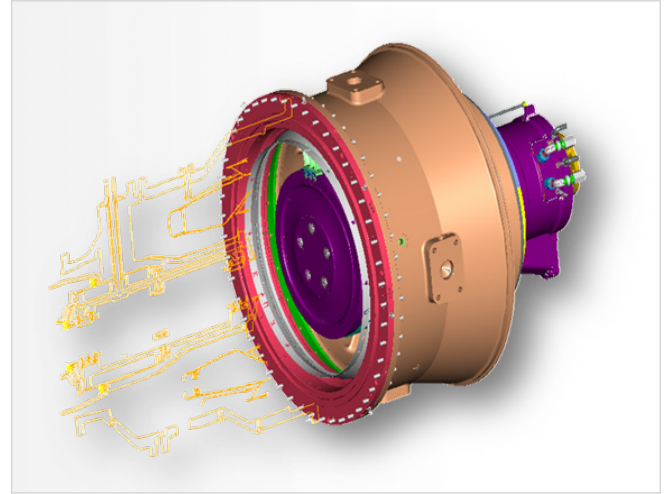
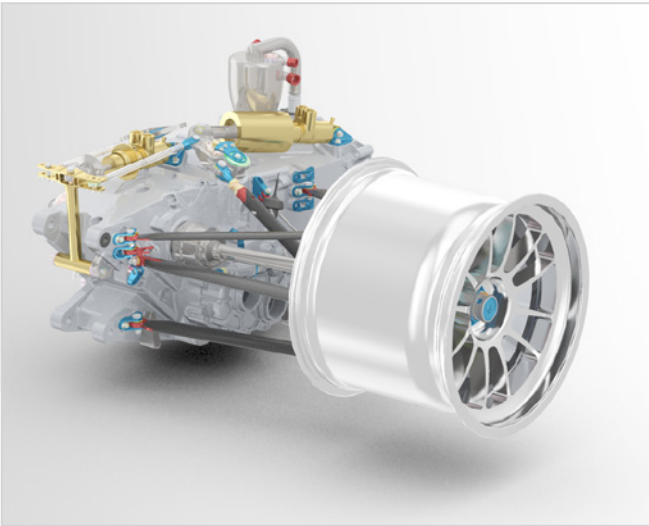

Capabilities of the package include:

- Creo Parametric, including Freestyle design capabilities
- Creo Flexible Modeling Extension for flexible design editing
- Creo Interactive Surface Design Extension for advanced surfacing
- Creo Advanced Rendering Extension for fast, high-quality photorealistic rendering
- Creo Sketch for easy, fast, 2D freehand drawing

Creo Concept Engineer

This package is tailored for design engineers who need more speed and flexibility in creating and exploring 2D and 3D design concepts. Whether simple or complex, many product designs start in 2D and can evolve into very detailed 3D designs. Creo gives you the capabilities to quickly create design concepts in 2D and 3D and seamlessly leverage the data in a downstream, detailed design process. The capabilities in the Creo Concept Engineer package will speed up your concept design process and accelerate the transition to detailed design.

Capabilities of the package include:

- Creo Direct for fast, easy 3D design concepts using direct modeling
- Creo Layout for 2D conceptual engineering design capabilities

Creo Design Reviewer

Many roles throughout a company need to review product designs throughout the product development process. From the earliest stages of incorporating customer input and in-process design review to post-development feedback from field engineers regarding design customization or improvement, users outside engineering need to see and interact with 3D design data. The Creo Design Reviewer package delivers easy to use visualization, markup and design-editing capabilities. Design reviewers now have the tools they need to communicate their ideas more efficiently and effectively. Better, faster design reviews can increase product quality and reduce design cycle time and cost.

Capabilities of the package include:

- Creo View MCAD for design visualization and collaboration capabilities
- Creo Direct for easy, flexible 3D design using direct modeling
- Creo Sketch for easy, fast, 2D freehand drawing

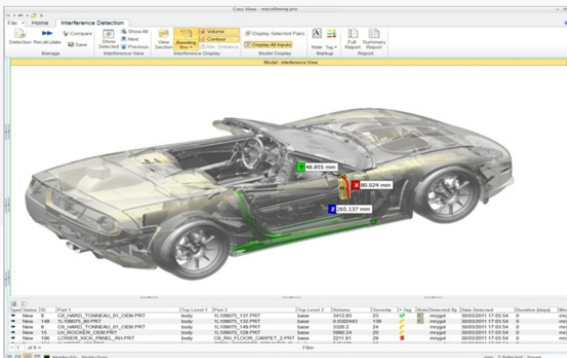

Other solutions for your role in product design

In addition to the products contained in these Creo packages, PTC offers precision tools that extend the power of Creo, providing specialized capabilities for even more roles in product development, including:

Tooling designers

Creo NC and tooling solutions offer powerful tools for machining, prismatic and multi-surface milling, tool design, moldbase design, NC sheetmetal, computer-aided verification of machined parts, plastic-filling process simulations, manufacturing work instructions and more.

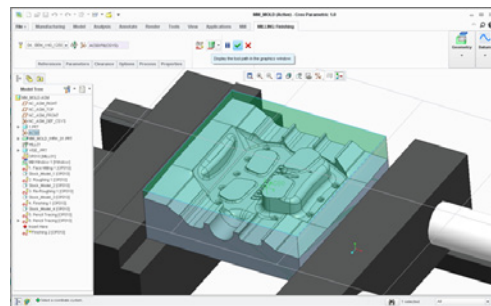

Electromechanical design engineers

Creo offers products optimized for 2D schematics and 3D cabling designs. You can also analyze the electromechanical performance of your design to ensure product safety. In addition, Creo provides industry-leading capabilities to help you visualize, compare and collaborate across MCAD and ECAD disciplines.

To learn more

Creo packages can be extended by adding more Creo apps and extensions.

For more information on Creo products, please visit PTC.com/products/creo or contact your local sales representative.

© 2012, Parametric Technology Corporation (PTC). All rights reserved. Information described herein is furnished for informational use only, is subject to change without notice, and should not be construed as a guarantee, commitment, condition or offer by PTC. PTC, the PTC logo, Creo, Windchill, Windchill PDMLink, Windchill ProjectLink, Mathcad, Arbortext, ModelCHECK, and all PTC product names and logos are trademarks or registered trademarks of PTC and/or its subsidiaries in the United States and in other countries. All other product or company names are property of their respective owners. The timing of any product release, including any features or functionality, is subject to change at PTC's discretion.